

# AC Coupled Inverter User Manual

LXP 3600ACS

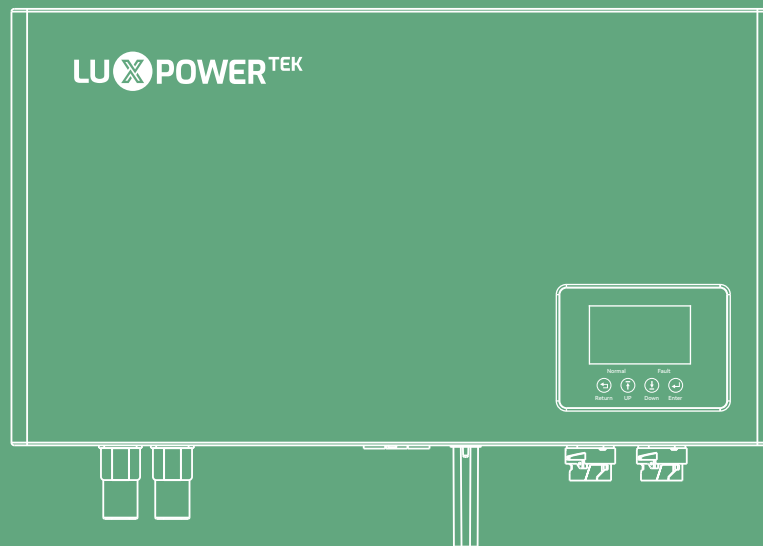

**LUX POWER<sup>TEK</sup>**

Copyright© 2024 Lux Power Technology Co., Ltd. All Rights Reserved. This manual, protected by the copyright and intellectual property rights of Lux Power Technology, may not be modified, copied, or reproduced without prior written permission. Brands and trademarks mentioned belong to their respective owners. Read carefully for product reliability and warranty eligibility. For warranty details, refer to Lux Power Technology Limited Warranty. Intended for professional service providers; no statements constitute an express or implied warranty.

Descriptions may contain predictive statements; differences may occur. Provided for reference, subject to change without notice by Lux Power Technology.



Website



YouTube



Facebook

 [www.luxpowertek.com](http://www.luxpowertek.com)



Scan to download

## Table Of Contents

<b>About This Manual</b>	1
Target Group	1
How to Use This Manual	1
<b>1. Information on this Manual</b>	2
1.1 Validity	2
1.2 Target Group	2
1.3 Storage of the manuals	2
1.4 Additional Information	2
1.5 Safety	2
1.5.1 Symbol Explanation	2
1.5.2 Safety Warning	3
<b>2. Working Modes Introduction</b>	3
<b>3. Installations&amp;Connection</b>	6
3.1 Packing List	6
3.2 Installation	7
3.2.1 Select Mounting Locat	8
3.2.2 Clearance Requirements	10
3.2.3 Installation the inverter	10
3.3 Connection	11
3.3.1 Grid Connection	11
3.3.2 UPS Connection	12
3.3.3 Battery Connection	13
3.3.4 Wiring The Whole System	14
3.3.5 Setting Safety Standard	14
3.3.6 Connecting Battery Communication Line/NTC And CTs	15
3.3.7 Install Wifi Module	18
<b>4. Display, Setting And Operation</b>	19
4.1 LCD Overview And Brief Introduction	19

4.2 General Information Checking And Settings ..... 20

4.2.1 General Information Display ..... 20

4.2.2 Start The Settings ..... 21

4.2.3 Time Settings ..... 21

4.2.4 Battery Settings ..... 23

4.2.5 UPS Settings ..... 24

4.2.6 AC Charge Settings ..... 26

4.2.7 Force Discharge Settings ..... 27

4.3 The Working/Warning/Fault Code Explanation ..... 28

**5. Start UP And Shutdown** ..... 28

5.1 Start-UP The LXP 3600ACS System ..... 28

5.2 Shut-down the LXP 3600ACS System ..... 28

**6. Troubleshooting&Maintenance** ..... 29

6.1 Troubleshooting ..... 29

6.2 Maintenance ..... 31

6.2.1 Inverter Maintenance ..... 31

6.2.2 Battery Maintenance ..... 31

**7. Manufacturer Warranty** ..... 31

**8. Specification** ..... 31

## Revision History

Version	Date	Description
UM-ACS36001E	2024.08.08	First official release.

## About This Manual

### Target Group

This Manual is only intended for qualified electricians who are responsible to the installation, commissioning and decommissioning of the inverter and system.

### How to Use This Manual

This manual is one of the most important part in the package of the inverter which describes the installation, connection, commissioning and maintenance etc. of the inverter. Please read the manual and related documents carefully before any work on the inverter is carried out.

The user or qualified operator should keep this manual stored carefully and accessible at any time. Once lost this manual for some reason, the soft copy can be download from the official website of Lux Power Technology or e-mailed from the service department.

# 1. Information on this Manual

## 1.1 Validity

This manual describes the assembly, installation, commissioning and maintenance of the following AC energy storage inverter from Shenzhen Lux Power Technology Co., Ltd.

## 1.2 Target Group

This manual is for qualified personnel who is well trained and has demonstrated skills and knowledge in the construction and operation of this device. Qualified personnel is trained to deal with the dangers and hazards involved in installing electric devices.

## 1.3 Storage of the manuals

Keep all relevant manuals and guidance documents from Shenzhen LuxPower Technology Co., Ltd in a safe place for any possible demands or usage in future.









## 1.4 Additional Information

You can find further information on special topics in the download area at [http:// www.luxpowertek.com](http://www.luxpowertek.com) or by asking, emailing the distributor and Shenzhen LuxPower Technology Co., Ltd

## 1.5 Safety

Please read and follow all the instructions and cautions on the inverter or user manual during installation, operation or maintenance. It calls attention to a procedure or practice, which, if not correctly performed or adhered to, could result in damage to or destruction of part or all of Luxpower equipment and /or other equipment connected to the Luxpower equipment or personal injury.

### 1.5.1 Symbol Explanation

 <p><b>DANGER</b> indicates a hazardous situation which, if not avoided, will result in death or serious injury.</p>	 <p><b>NOTICE</b> is used to address practices not related to personal injury.</p>
 <p><b>CAUTION</b> indicates a hazardous situation which, if not avoided, could result in minor or moderate injury.</p>	 <p><b>Earth Ground</b></p>
 <p><b>Beware of hot surface</b> The product can become hot during operation. Don't touch the product during operation.</p>	 <p><b>CE Mark</b></p>
  <p>Inverter will be touchable or operable after minimum 5 minutes of being turned off or totally disconnected, in case of any electrical shock or injury.</p>	

### 1.5.2 Safety Warning

- Any installation and operation of inverter must be performed by qualified electricians. The appliance is not to be used by children or persons with reduced physical sensory or mental capabilities, or lack of experience and knowledge, unless they have been given supervision or instruction.
- Before any wiring connection or electrical operation on inverter, all battery and AC power must be disconnected from inverter for at least 5 minutes to make sure inverter is totally isolated to avoid electric shock.
- During operation, the upper lid of the enclosure and the enclosure body may become hot. Only touch the lower enclosure lid during operation, and make sure the inverter is untouchable for children.
- Usage and operation of the inverter must follow instructions in this user manual, otherwise any injury or damage and warranty is not warranted by Lux Power Technology.
- Don't open inverter's cover or change any components, otherwise the warranty commitment for inverter will be invalid.
- DC differential currents from battery are created, thus an external RCD(type A) can be used( $\geq 30\text{mA}$ ) in the AC output of the LXP 3600ACS. As the LXP 3600ACS used with PV inverters in the system, so the PV inverters are creating residual current too, in order to prevent unwanted triggering during operation, we recommend that the rated residual current of the RCD has to be min 50mA.
- In Australia, the inverter internal switching does not maintain neutral integrity, which must be addressed by external connection arrangements like in the system connection diagram for Australia on page 8.

## 2. Working Modes Introduction

LXP 3600ACS AC Couple energy storage inverter is designed for indoor and outdoor usage with existed grid-connected solar power systems want to retrofit with batteries to store energy. It has five modes to satisfy the PV+Storage system.

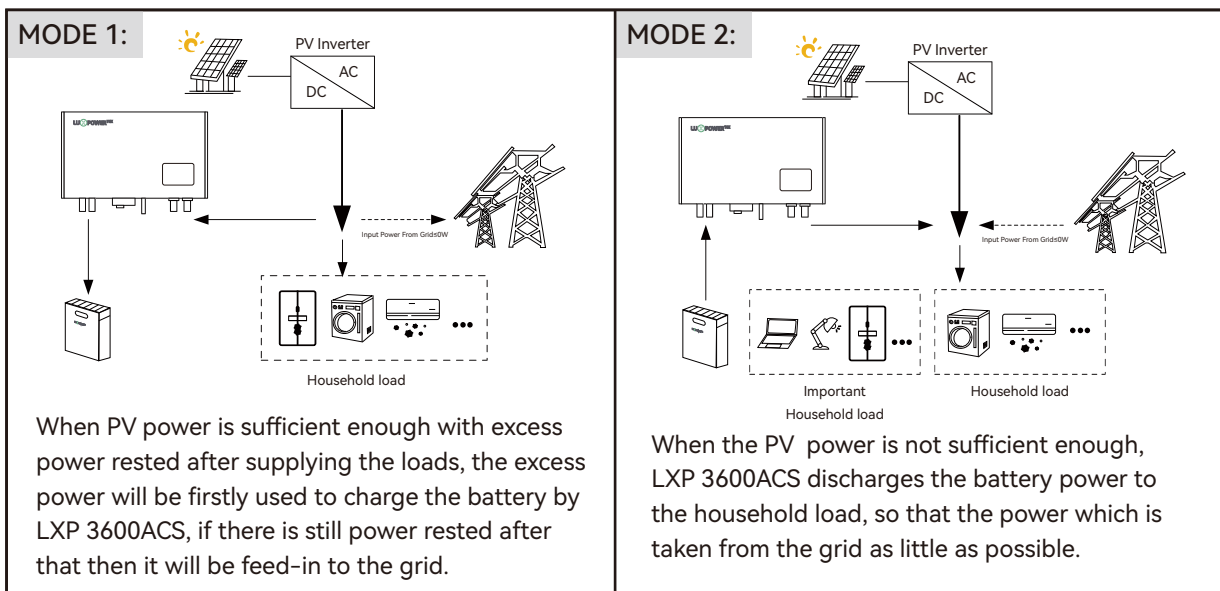

**MODE 3:**

When grid power fails, immediately, the LXP 3600ACS discharges the battery power to the important household load using uninterrupted power supply technology which will guarantee the power supply stability and continuously of important loads. (Notice that it's required to enable the UPS function to activate this working mode.)

**MODE 4:**

Battery can be charged by grid power (AC charge mode) by enable relevant functions and make right settings according to the real demands on the AC charge function via LCD operation, monitoring website or the APP.

**MODE 5:**

LXP 3600ACS can be set to "Force Discharge" mode, no matter PV inverter output energy is sufficient or not, the LXP 3600ACS discharge the power to the grid and Time&power&SOC limit can be set flexibly via LCD operation, monitoring website or APP.

**LXP 3600ACS MICRO-GRID MODE:**

It is applied in the micro-grid system. During the day, the energy generated by the diesel generator is stored in the battery, and the power is supplied to the load from the network at night. It is suitable for the micro-grid environment that needs quiet electricity at night. In this mode, 10 units can be connected in parallel with a power of 36kW.

This mode needs special hardware version and firmware version, please contact to Shenzhen Lux Power Technology Co., Ltd

Diesel generator

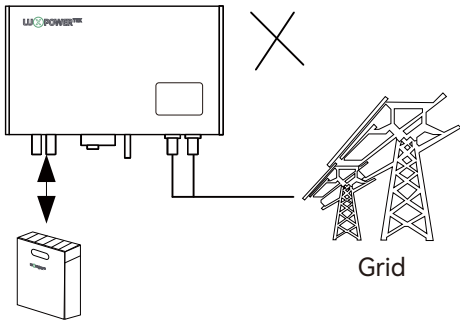
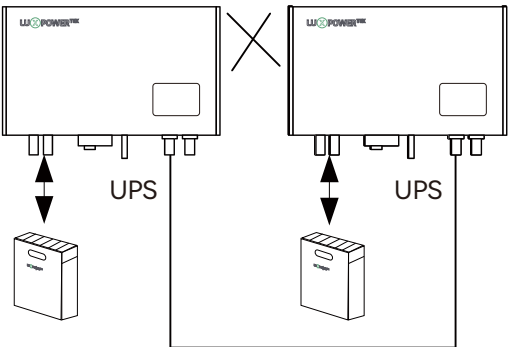
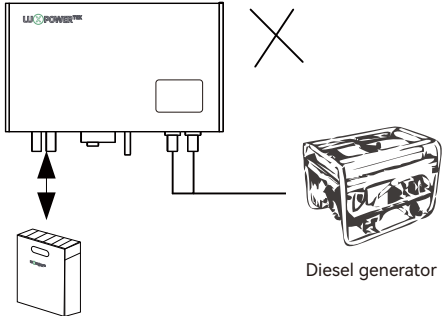
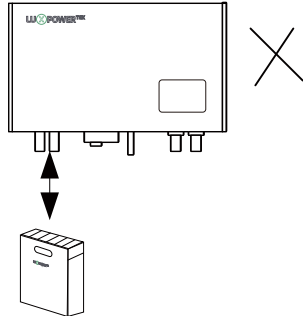

### Forbidden System Connections

 <p>UPS side can't connect to Grid.</p>	 <p>Without the micro-grid mode version hardware and firmware, UPS side should not be paralleling connected.</p>
 <p>Without the micro-grid mode version hardware and firmware, On-Grid or UPS side should not be connected to any AC generator.</p>	 <p>Incompatible battery</p> <p>If it is 48V pack, and no incompatible batteries could be setting as lead-acid mode in LCD, website or the APP.</p>

### 3. Installations&Connection

#### 3.1 Packing List

Please check to make sure all the components as below are in good condition.

 <p>Inverter X1</p>	 <p>User manual X1</p>	 <p>Quick installation guidance X1</p>	 <p>Communication cover X1</p>
 <p>AC connector X1</p>	 <p>UPS connector X1</p>	 <p>Lead-acid battery NTC kit X1</p>	 <p>Wi-Fi Module X1</p>
 <p>Pan head screw M3*8 M4*4</p>	 <p>Nylon Wire Cap X4</p>	 <p>Explosion Screws X4</p>	 <p>Battery communication cable X1</p>
 <p>Connector for BAT+</p>	 <p>Connector for BAT-</p>	 <p>CT clamp (RJ11 plug) X1</p>	 <p>CT clamp (RJ45 plug) X1</p>
 <p>4mm Allen Key X1</p>	 <p>2mm Allen Key X1</p>	 <p>Guardrail barrier X1</p>	

### Product Overview and Connection Overview

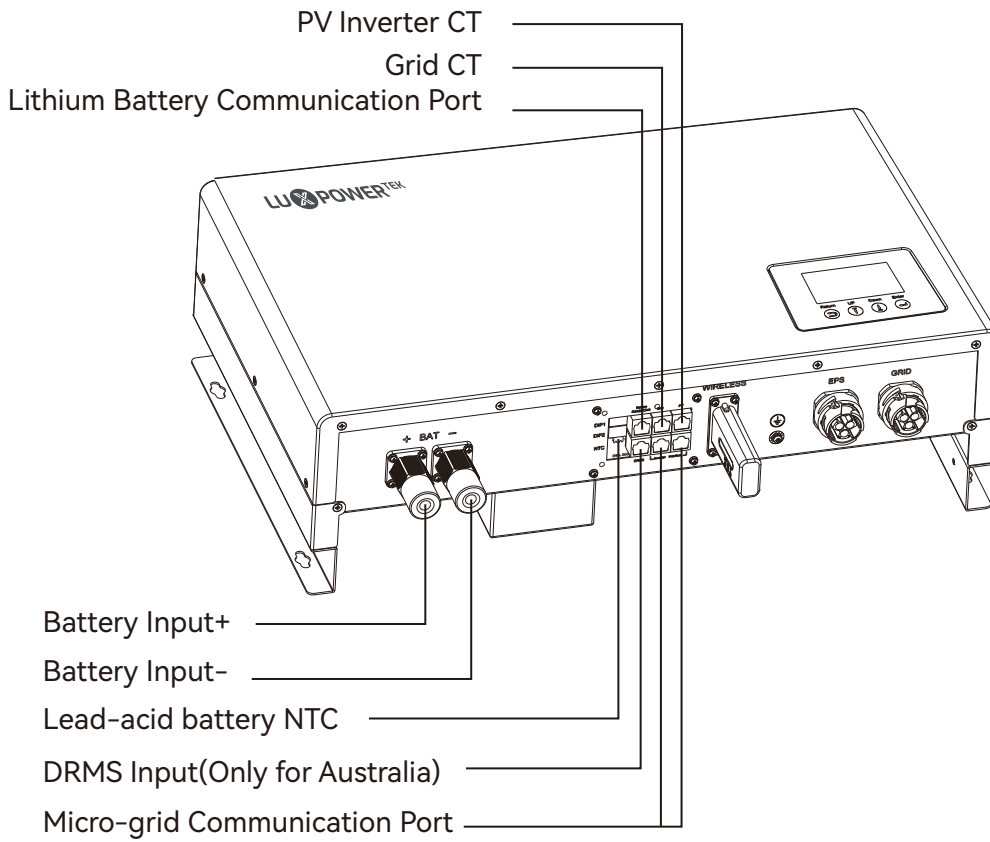

### 3.2 Installation

#### SYSTEM CONNECTION DIAGRAMS

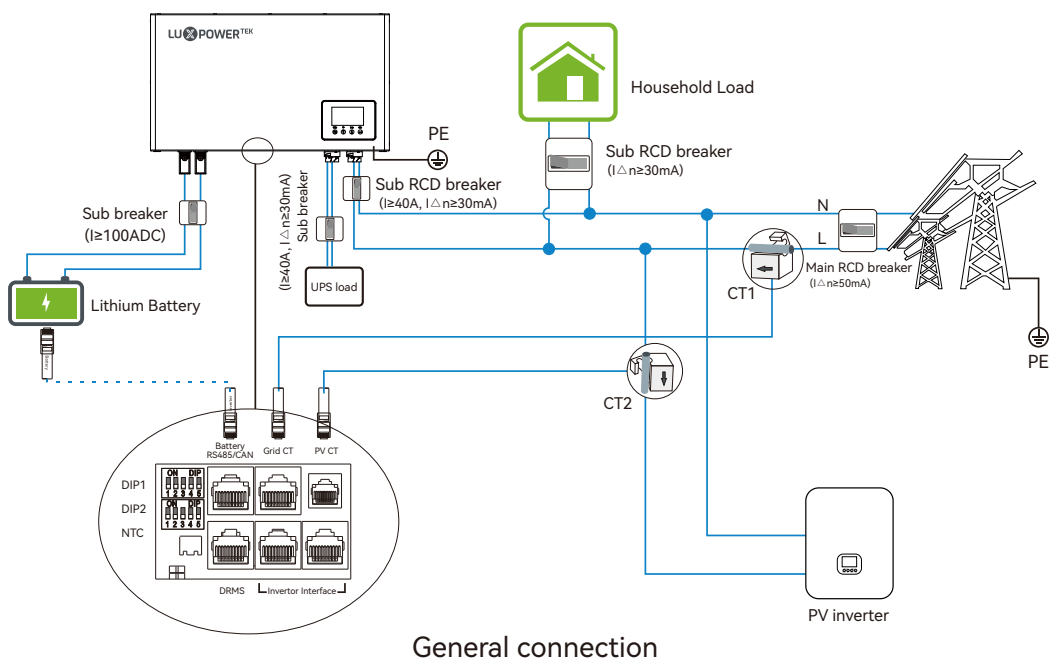

**CAUTION**

- For Australian safety country, the neutral cable of On-Grid side and Back-up side must be connected, otherwise Back-up function will not work.

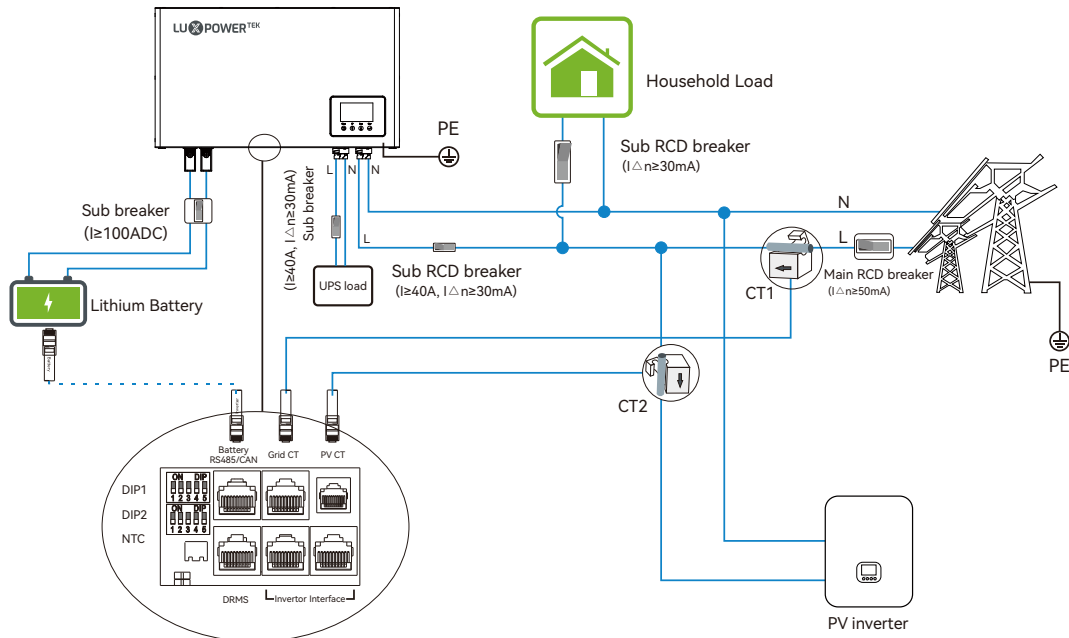

The diagram is for Australian and New Zealand grid system

### 3.2.1 Select Mounting Locat

The LXP 3600ACS is designed as IP65 devices with a capability to be installed in both outdoor and indoor conditions. However, selecting an optimal installation location is highly recommended to increase the safety, performance and lifespan of the inverter.

**Suggestions and requirements**

- a) The wall for mounting should be strong enough to bear the weight of the inverter during system's service time period.
- b) The wall for mounting should be suitable with the dimension of the inverter during system's service time period.
- c) Please make sure the wall thickness is over 70mm.
- d) The install should not be accessible to children for safety consideration.
- e) The ambient temperature is required to be within -25°C~60°C.
- f) To ensure the heat dissipation efficiency and inverter's lifespan, do not install the inverter enclosed.
- g) The structure of the wall where inverter mounted should not be flammable, or make sure the inverter is not surrounded by any flammable or corrosion materials and is away from the gas.
- h) Never install the inverter exposed to directly sunshine, rain and snow. Please refer to fig.3.10 to select a well shaded place or install a shell to protect the inverter from directly sunshine, rain and snow etc.

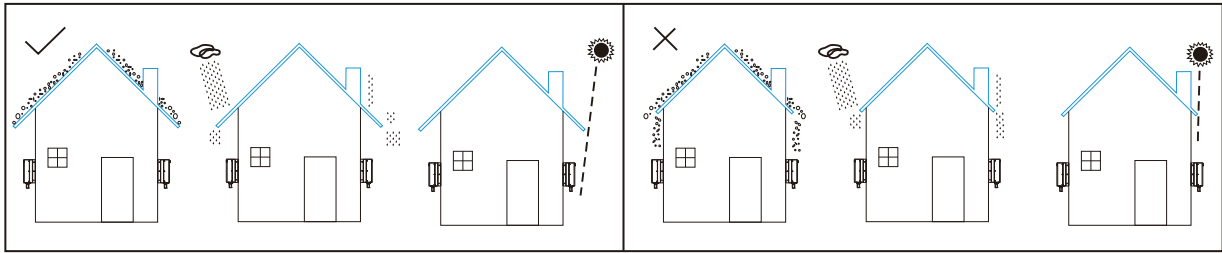

i) The inverter should be installed vertically on the wall, or lean back on plane with a limited tilted angle. Please refer to below.

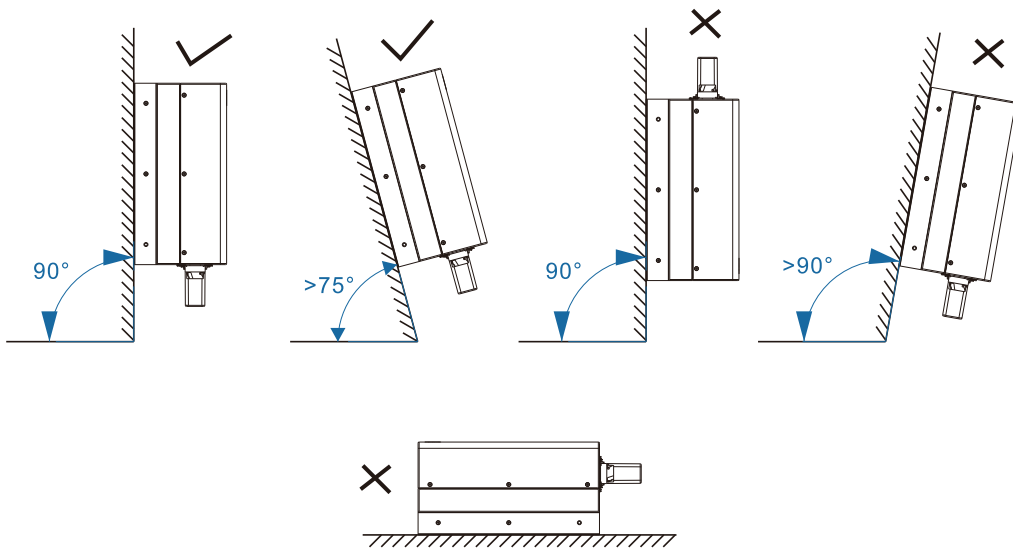

j) Do not install the inverter in living area.

k) Do not install the inverter near TV antenna or other antenna or antenna cables.

l) Make sure there are enough space of the location for easy access to the inverter, relevant connection points and switches in future operation and maintenance.

m) The height of installation should be reasonable to make sure easy operation and view the display of the inverter.

**⚠ DANGER**

- In order to prevent any electric shocks or other injuries, please make sure there are no electricity, plumbing or gas pipeline in the wall where selected to drilling holes for installation.

### 3.2.2 Clearance Requirements

To ensure the inverter working normally and easy to operate, there are requirements on available spaces of the inverter, e.g. to keep enough clearance.

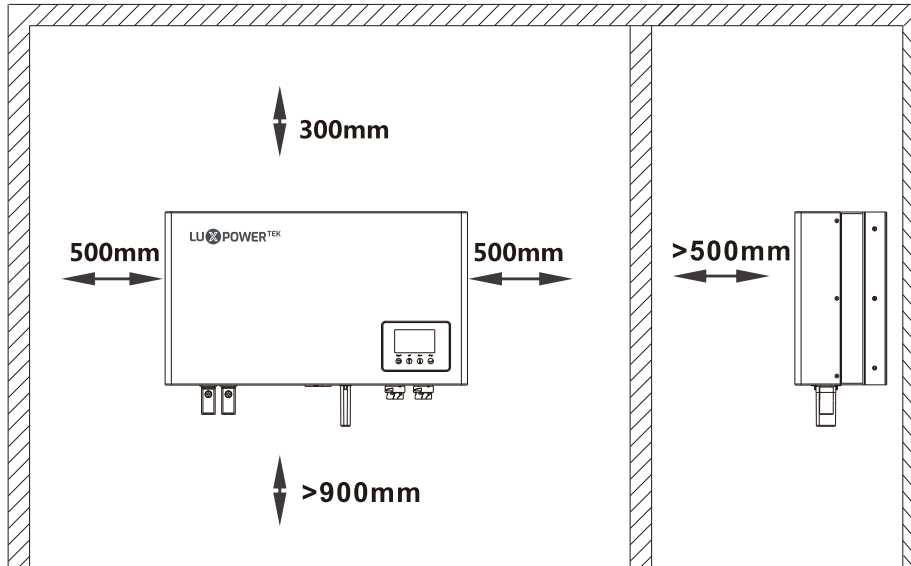

### 3.2.3 Installation the inverter

**CAUTION**

- To prevent potential damages and injuries from inverter falling down, please carefully hang the inverter on the bracket, don't loosen grip unless confirm the inverter is well mounted on the inverter.

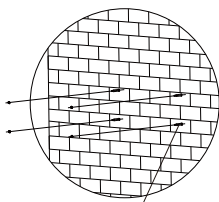

4\*M6 Explosion Screws

- Step 1.** Position the machine's probably size onto the wall; the thickness of wall for LXP 3600ACS at least 60mm.
- Step 2.** Drill 4 holes of 8mm (5/16in.) diameter at the marked point, the depth is not less than 50mm.
- Step 3.** Knock four explosion screws into the holes.

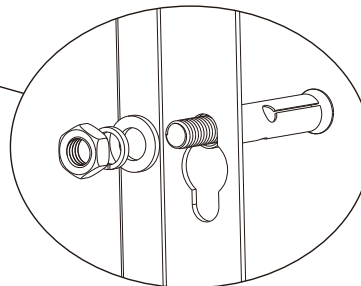
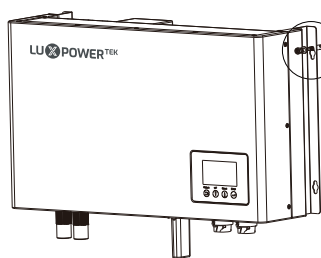

M6 Explosion Screw

- Step 4.** Mount the inverter onto the four explosion screws.
- Step 5.** Lock the nut of setscrew and finish the inverter installation.

### 3.3 Connection

**⚠ CAUTION**

- Make sure the inverter is totally isolated from any DC or AC power before connection.

#### 3.3.1 Grid Connection

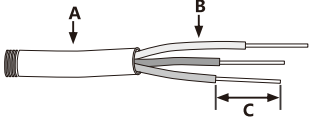
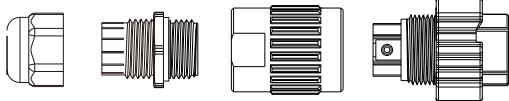
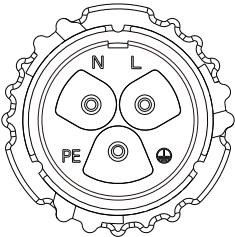
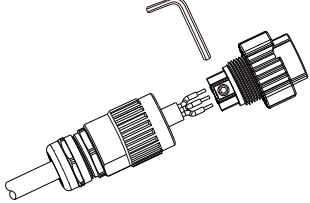
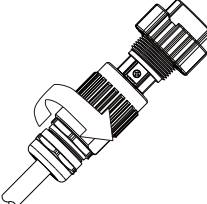
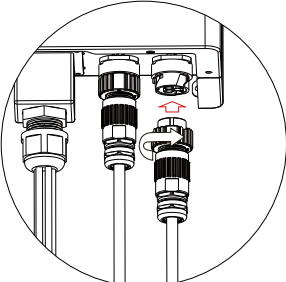
<p><b>a</b> Cable Requirements:</p>  <p>A. Diameter 10~12 mm</p> <p>B. Cross Section 3~4mm<sup>2</sup></p> <p>C. Strip Length 10 mm</p>	<p><b>b</b> Uninstall the AC connector.</p>  <p>Pressure screw   Seal ring   Threaded sleeve   Connection terminal</p>
<p><b>c</b> Confirm the L, N, PE Ports to the Grid lines are correct.</p> <p><b>It have 1 limit slot</b></p> 	<p><b>d</b> Lead the AC cable through cable gland, seal ring and threaded sleeve, and fully insert the conductors to corresponding terminals on connection terminal and tighten the screws.</p> 
<p><b>e</b> Assemble the AC connector and make sure that the rib of the terminal block and the groove on the housing engage perfectly.</p> 	<p><b>f</b> Push threaded sleeve on to connection terminal until both are locked tightly.</p> 

3.3.2 UPS Connection

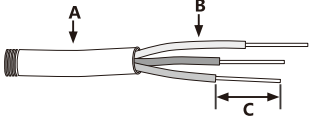
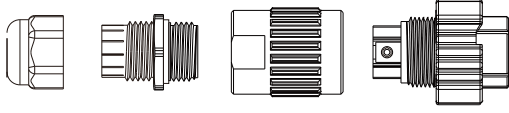
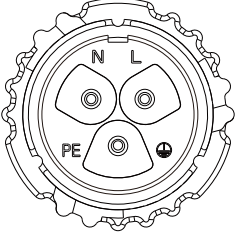
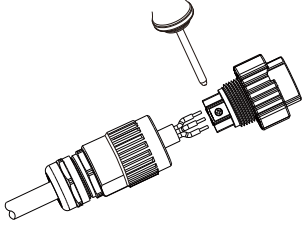
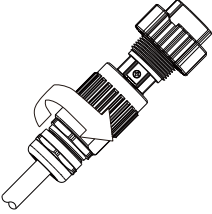
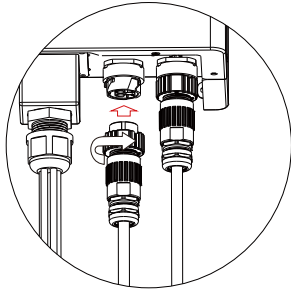
<p><b>a</b> Cable Requirements:</p>  <p>A. Diameter 10~12 mm</p> <p>B. Cross Section 3~4mm<sup>2</sup></p> <p>C. Strip Length 10 mm</p>	<p><b>b</b> Uninstall the UPS connector.</p>  <p>Pressure screw   Seal ring   Threaded sleeve   Connection terminal</p>
<p><b>c</b> Confirm the L, N, PE Ports to the UPS load lines are correct.</p> <p><b>It have 5 limit slot</b></p> 	<p><b>d</b> Lead the UPS cable through cable gland, seal ring and threaded sleeve, and fully insert the conductors to corresponding terminals on connection terminal and tighten the screws.</p> 
<p><b>e</b> Assemble the UPS connector and make sure that the rib of the terminal block and the groove on the housing engage perfectly.</p> 	<p><b>f</b> Push threaded sleeve on to connection terminal until both are locked tightly.</p> 



### 3.3.3 Battery Connection

**⚠ CAUTION**

- This part in this manual only describe the battery connection on inverter side, should you need more detailed information regarding the battery connection on battery side please refer to the manual of the battery you are using.
- Mind that battery positive (+) and negative pole (-) reverse will damage the inverter and battery.

<p><b>a</b></p> <table border="1"> <tr> <td>A. Diameter</td> <td>10~12 mm</td> </tr> <tr> <td>B. Cross Section</td> <td>20~25mm<sup>2</sup></td> </tr> <tr> <td>C. Strip Length</td> <td>-10 mm</td> </tr> <tr> <td>D: Accessories</td> <td>Battery terminal</td> </tr> </table>	A. Diameter	10~12 mm	B. Cross Section	20~25mm <sup>2</sup>	C. Strip Length	-10 mm	D: Accessories	Battery terminal	<p><b>b</b> Crimp the OT terminal, install the heat shrinkable casing.</p>
A. Diameter	10~12 mm								
B. Cross Section	20~25mm <sup>2</sup>								
C. Strip Length	-10 mm								
D: Accessories	Battery terminal								
<p><b>c</b> Lead the battery cable with OT terminal through waterproof sleeve and cable rubber ring.</p>	<p><b>d</b> Connect positive pole (+) of battery cable to battery positive terminal (+) of the inverter, connect negative pole (-) of battery cable to battery negative terminal (-) mind that the OT terminals should be inverted into the battery terminals on inverter.</p>								
<p><b>e</b> Using 2*M6 screws to tighten the positive terminal (+) and battery negative terminal (-) on inverter.</p> <p>⊕ Red Cable ⊖ Black Cable</p> <p><b>Warning!</b> Polarity reverse will damage the inverter!</p>	<p><b>f</b> Tighten the waterproof sleeve perfectly and finished.</p>								

### 3.3.4 Wiring The Whole System

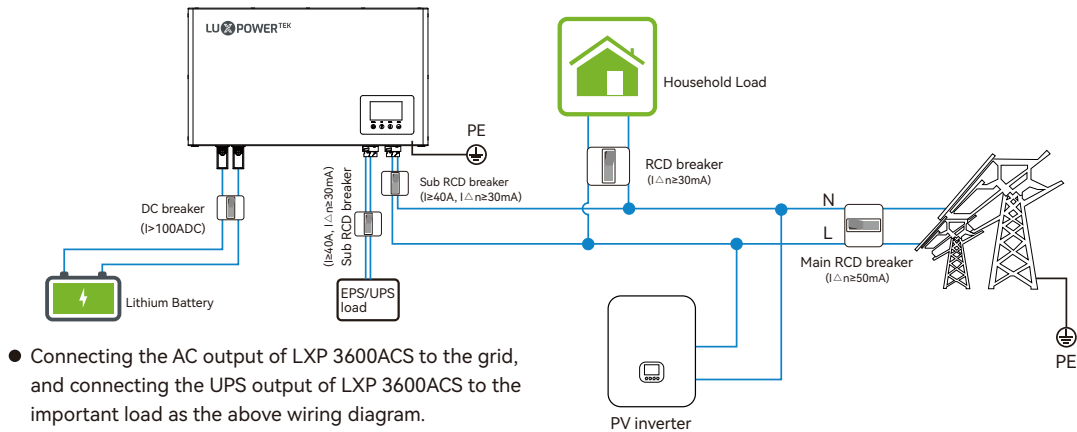

**CAUTION**

- An external RCD (type A) can be used ( $\geq 30\text{mA}$ ) in the UPS output of the LXP 3600ACS and the input of household Load.
- As the LXP 3600ACS used with PV inverters in the system, so the PV inverters are creating residual current too, in order to prevent unwanted triggering during operation, we recommend that the rated residual current of the Main RCD Breaker has to be  $\geq 50\text{mA}$ .
- The AC breaker in the Grid output of the LXP 3600ACS is suggested to be  $\geq 40\text{A}$ . And the DC breaker of the battery is suggested to be  $\geq 100\text{A}$ . For batteries with attached switch, the external DC switch is not necessary.

NOTE: For Australian and New Zealand safety country, the neutral cable of On-Grid side and Back-Up side must be connected together, please refer to page B: the wiring diagram for Australian and New Zealand grid system.

### 3.3.5 Setting Safety Standard

Setting safety with DIP1 dial switch as below:

Setting DIP1 and DIP2 configurations.  
NOTE: The DIP switch is composed of five-digit binary number PINs. Each PIN has two statuses, when set upward to "ON", its value turns to "1", when set downward, its value turns to "0".

Country Standard	DIP1 Configuration	Country Standard	DIP1 Configuration
Germany VDE0126	ON DP 1 2 3 4 5 0 0 0 0 1	United Kingdom G99	ON DP 1 2 3 4 5 0 0 1 0 1
Australia AS4777	ON DP 1 2 3 4 5 0 0 0 1 0	United Kingdom G98	ON DP 1 2 3 4 5 0 0 1 1 0
New Zealand NZS	ON DP 1 2 3 4 5 0 0 0 1 1	Germany N4105	ON DP 1 2 3 4 5 0 0 1 1 1
Italy CEI0-21	ON DP 1 2 3 4 5 0 1 0 0 0	Europe EN50438	ON DP 1 2 3 4 5 0 1 0 0 1
CEI0-21 ARET	ON DP 1 2 3 4 5 1 0 0 1 0	POLAND	ON DP 1 2 3 4 5 1 0 1 0 1
Default VDE0126	ON DP 1 2 3 4 5 0 0 0 0 0	China CGC	ON DP 1 2 3 4 5 0 0 1 0 0
		EN50549	ON DP 1 2 3 4 5 1 0 0 1 1

### 3.3.6 Connecting Battery Communication Line/NTC And CTs

**NOTICE**

- Before any installations, must read following description of battery communication port and “NTC” port.
- Before any installations, must read following description of DRMS port (Only for Australian safety).

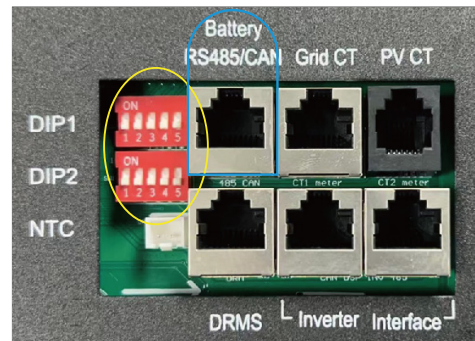
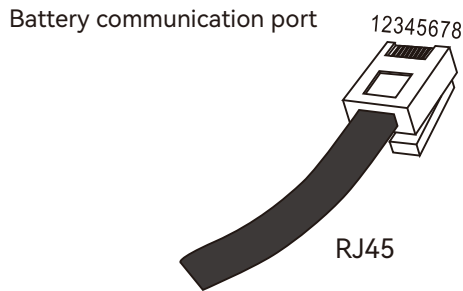

Red color switch		
Pin	RS485 Port	CAN Port
1	RS 485B	/
2	RS 485A	/
3	/	CANL
4	/	CANH
5	/	/
6/7/8	/	/

Blue color switch		
Pin	RS485 Port	CAN Port
1	RS 485B	/
2	RS 485A	/
3	/	/
4	/	CANH
5	/	CANL
6/7/8	/	/

DPMS port(Only for Australian safety)

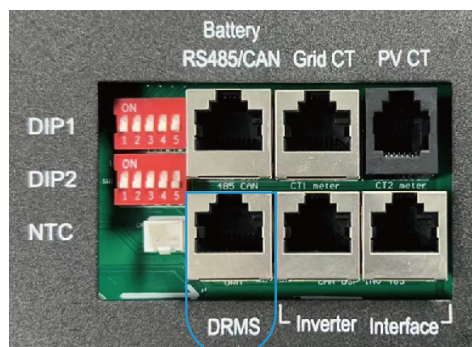
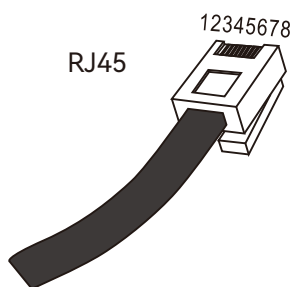

PIN number	Description
1	DRM1/5
2	DRM2/6
3	DRM3/7
4	DRM4/8
5	REF GEN/0
6	COM/DRM 0
7	V+
8	V-

NTC port and Reserved ports

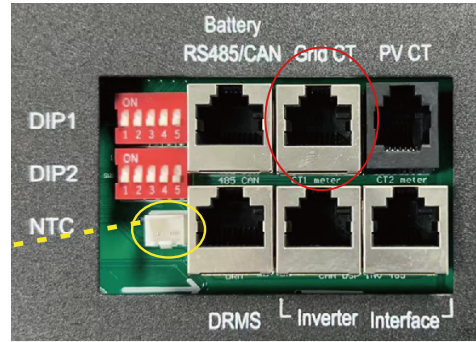
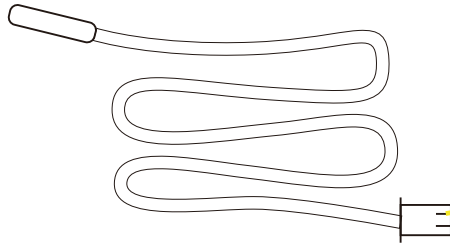

Red color switch	
Pin	Function Description
1	Meter RS 485-B
2	Meter RS 485-A
3	/
4	/
5	Grid CT1-N
6	Grid CT1-P
7	Grid CT1-N
8	Grid CT1-P

Blue color switch	
Pin	Function Description
1	Meter RS 485-B
2	Meter RS 485-A
3	Debugging RS 485-B
4	Debugging RS 485-A
5	Grid CT1-N
6	Grid CT1-P
7	Grid CT1-N
8	Grid CT1-P

Connecting battery communication cable/NTC cable and clamps.

1. Don't cut off any battery communication cable or CT cable as the seal ring's holes are pre-mark as "half-cut" on its surface. It is easy to put the cable into the corresponding seal ring's hole.
2. If the battery type is lithium-ion or ternary battery which needs communication between the inverter and battery management system (BMS), the communication connection must be made. The attached communication cable in inverter package may not suitable for all battery brands, please check if the battery communication port is compatible with your battery.
3. If the battery type is lead acid, which needs battery NTC cable kit to monitor battery ambient temperature.
4. Direction of the Grid side CT clamp cannot be connected in reverse, please follow "Grid-House" direction to make the connection.

**CAUTION!**

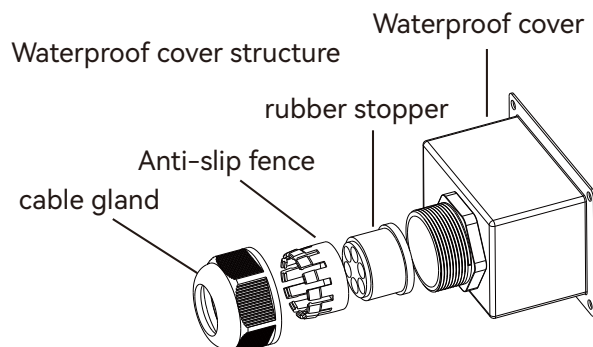
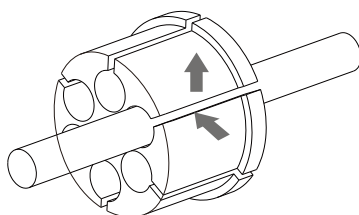

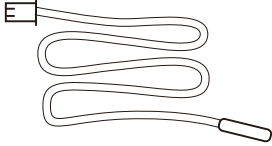
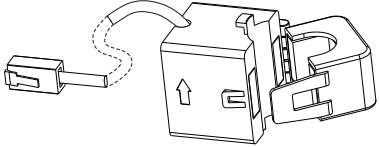
<p>Cable Requirements:</p> <p>1. "Batterycommunication cable" (lithium battery CAN/RS485 communication)</p> 	<p>2. "NTC" (For lead-acid battery)</p> 	<p>3. "CT cable" (With RJ485)</p> <p>4. "CT cable" (With RJ11)</p> 
---	---	--

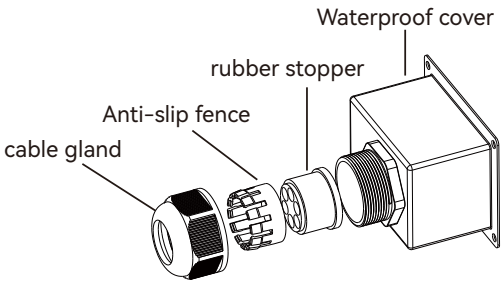
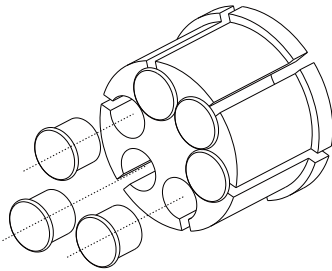
<p><b>Step 1.</b> Unscrew the swivel nut from the cable gland.</p> 	<p><b>Step 2.</b> Remove 3 plug-columns from the rubber stopper and others reserved.</p> 
--	---

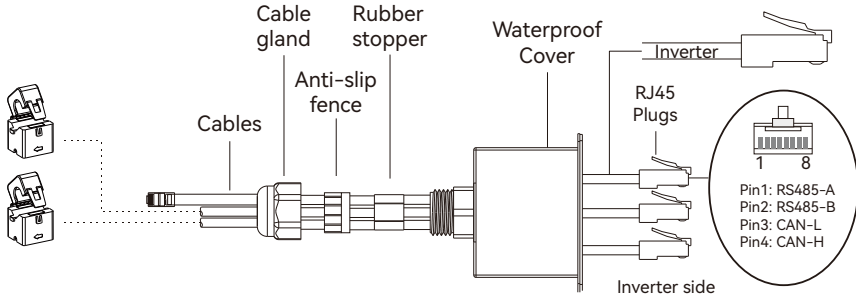
<p><b>Step 3.</b> Put the Battery communication cable(lithium battery )/"NTC" (lead-acid battery ) and CT cables cross into the cable gland, anti-slip fence, rubber stopper, waterproof cover one by one.</p>  <p>Pin1: RS485-A Pin2: RS485-B Pin3: CAN-L Pin4: CAN-H</p>	
--	--

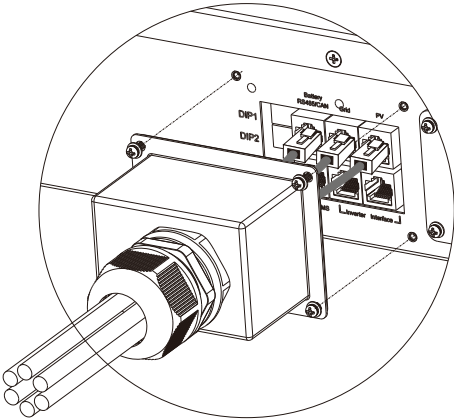
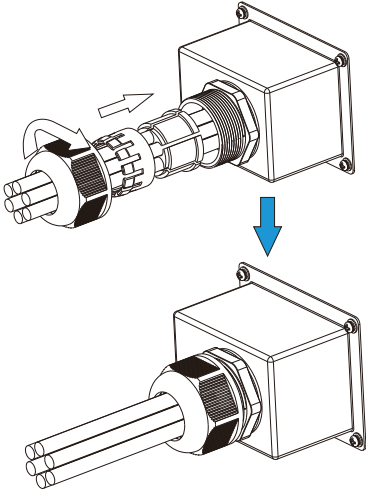
<p><b>Step 4.</b> Insert the RJ45 plug of the network cable into the "RS485" place inverter until it snaps.</p> <p><b>Step 5.</b> Lock the RJ45 waterproof cover with the combination 4*M3 screws and finished.</p> 	<p><b>Step 6.</b> Lock the RJ45 waterproof cover with the combination 4*M3 screws and finished.</p> 
---	--

**Step 7.** If lithium battery connecting the Battery communication cable the side with label of “Battery” (lithium battery) to the lithium battery communication port. If lead-acid battery, just let the NTC near the lead-acid battery surface.

**Step 8.** Catching the CT1 to the grid L line from grid and the direction is "Grid→House". Catching the CT2 to the grid L line of the inverter output.

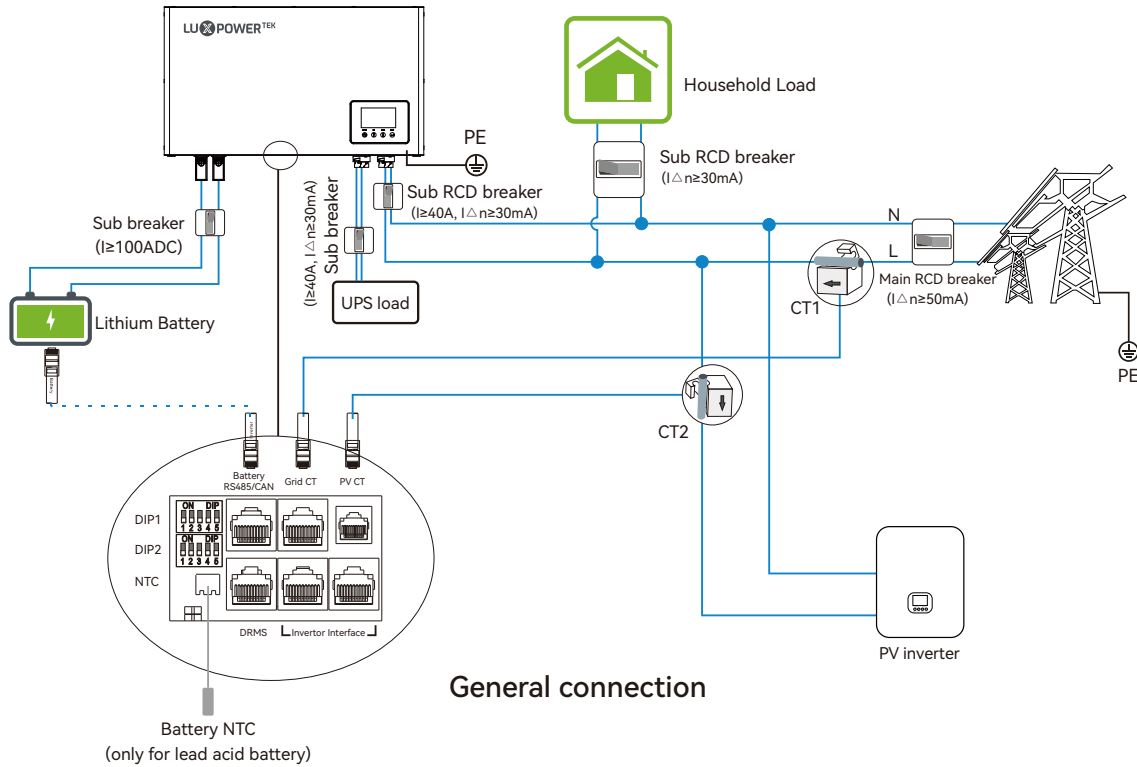

NOTE: For Australian and New Zealand safety country, the neutral cable of On-Grid side and Back-Up side must be connected together, please refer to page 8: the wiring diagram for Australian and New Zealand grid system.

### 3.3.7 Install Wifi Module

Using four M3 screws to screw the WIFI module to the inverter.

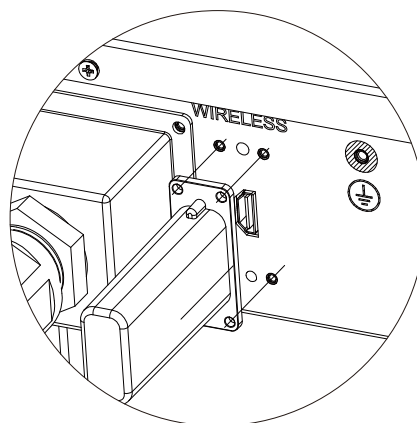

## 4. Display, Setting And Operation

### 4.1 LCD Overview And Brief Introduction

This type LCD screen contains the system information display and setting functions, the overview of the LCD screen is shown below:

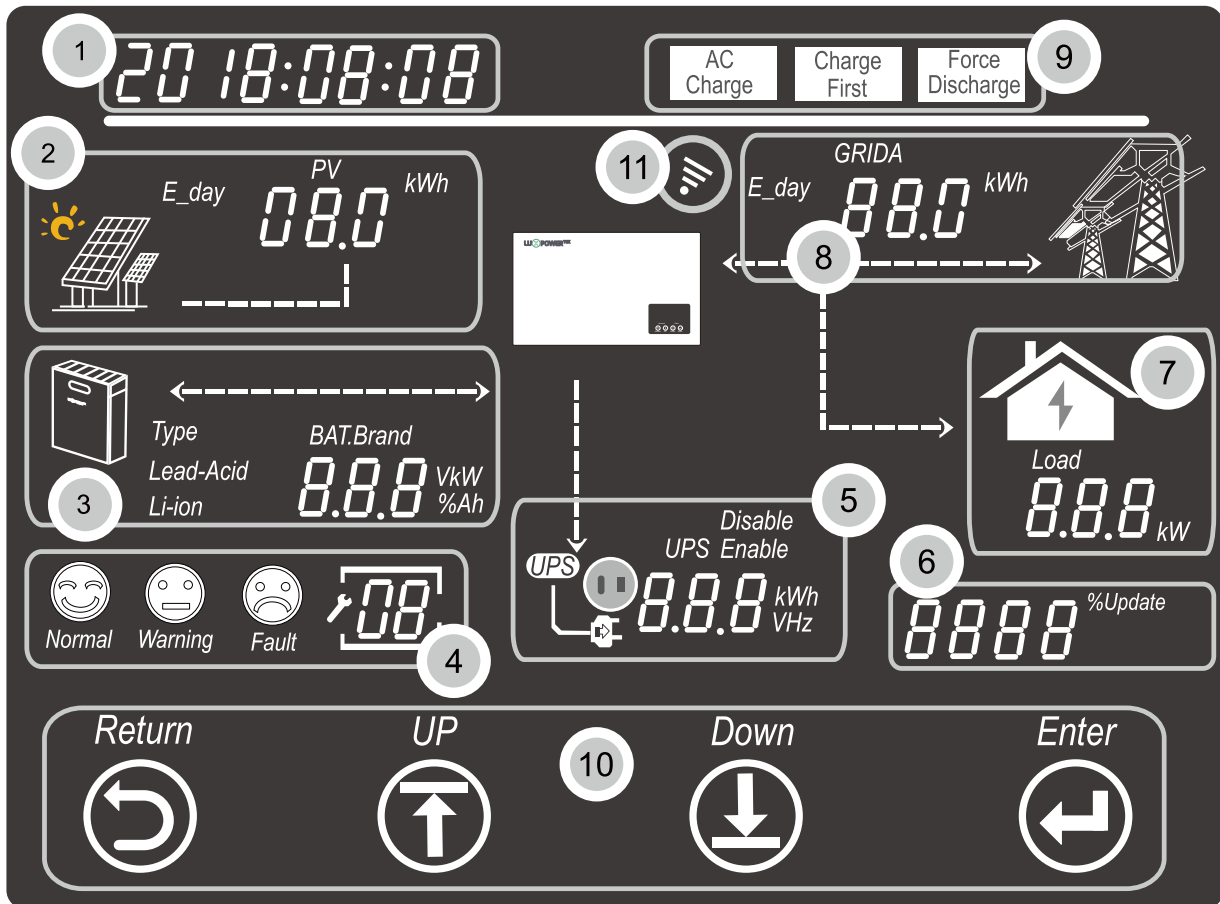

Screen Interface instruction:

No.	Description	Remarks
1	Generally Information Display Area	This area will display the currently time/date by default (year “month: day, and hour: minute” switching automatically). When press Up or Down buttons, this area will display the firmware version information, serial number etc.
2	On-grid solar inverter output power and energy data	This area shows only the data monitored by the LXP ACS inverter through the CT clamp installed at the existed on-grid solar inverter output side.
3	Battery information and data	This area shows the battery type, battery brand (lithium battery), and displays the voltage, SOC and power in turns of period of 1 seconds.

4	System working status	There are three type of working status-normal, warning and fault, in right side of this area, there are code display, it will display different type of code-the system working mode code, warning code and fault code.
5	UPS/EPS output information data	When UPS function is enabled, this area will display UPS voltage, frequency, power etc. in turns of periods of 1s.
6	Programming and Auto Test	When Auto Test process is occurring (only for Italy standard) or firmware updating in process, it will display relevant information.
7	Loads consumption	Display the power consumption by the loads.
8	Grid information	Display the grid information of voltage, frequency, input or output power, switch period of 1s.
9	Working mode settings area	When make settings on the LXP ACS inverter through the LCD, this area will display the AC Charge, Force Discharge, Charge First option for setting on those working modes. It will not display those information unless in the setting process.
10	Touch buttons	Return, Up, Down and Enter touch button for operation through the LCD.
11	WiFi Module Connection Signal	When WiFi module is connected to LXP ACS and the communication between them is normal, this signal will displayed in this area.

## 4.2 General Information Checking And Settings

### 4.2.1 General Information Display

When the LCD automatically displays the system general information, it will display as below image shows:

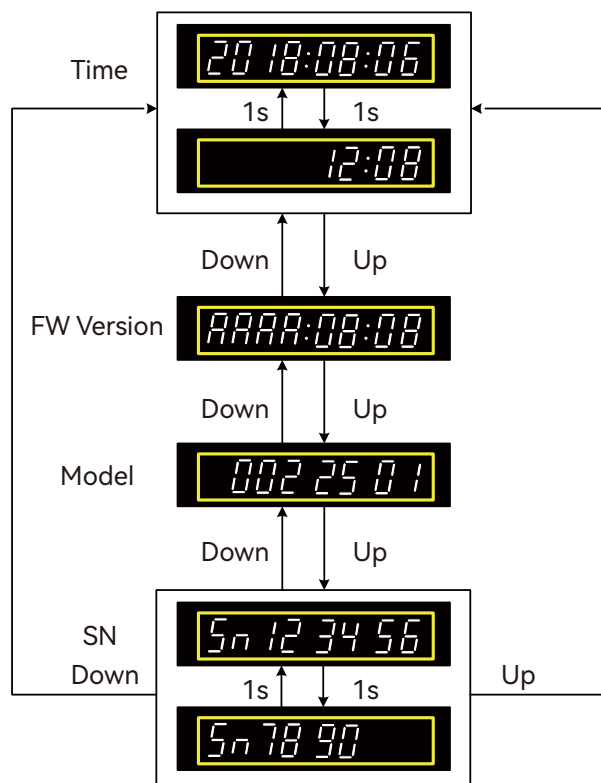



### 4.2.2 Start The Settings

When the system is not in Auto Test or Programming status, then please press Return button access into the setting process:

When pressed Return button the area 1 (for fine setting) will flashing at the start, you can press UP and Down buttons to select what to set, and then press Enter button to start the settings on selected setting options.

### 4.2.3 Time Settings

To set the time of the LXP ACS inverter, please follow below steps:

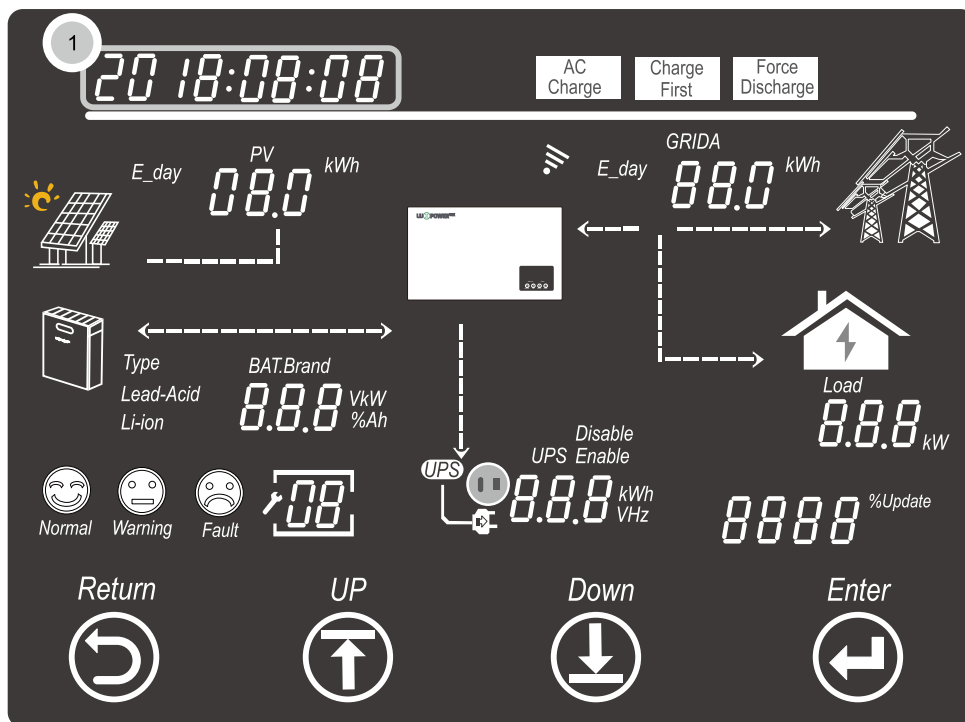

- Set the year:

When the display area ① will flashing, press Enter button to set the year, press UP and Down buttons to change the year number, and press Enter button to confirm and finish the year setting.

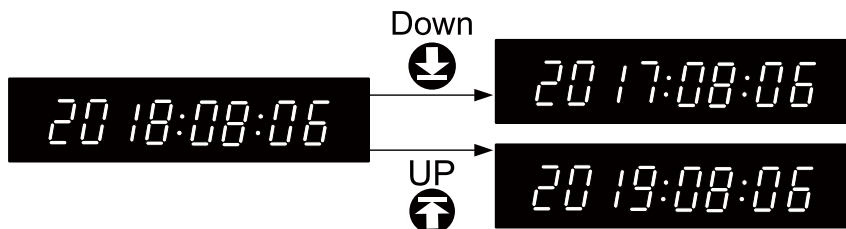

- Set the Month:

When finished the years setting then the month number will flashing, press UP and Down buttons to change the month number, and press Enter button to confirm and finish the month setting.

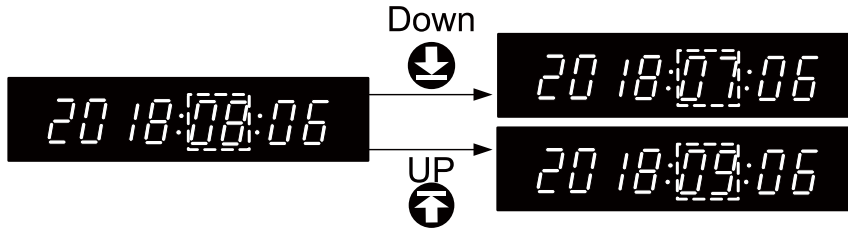

- Set the Day:

When finished the months setting then the day number will flashing, press UP and Down buttons to change the day number, and press Enter button to confirm and finish the day setting.

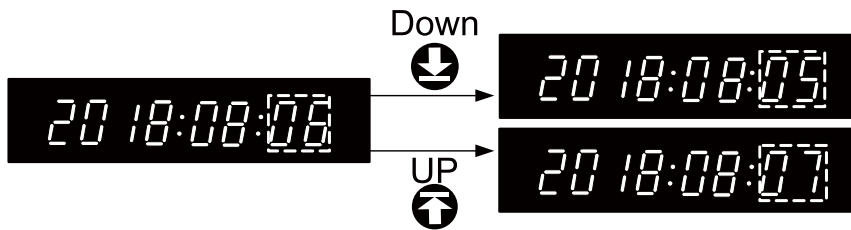

- Set the Hour:

When finished the days setting then the hour number will flashing, press UP and Down buttons to change the hour number, and press Enter button to confirm and finish the hour setting.

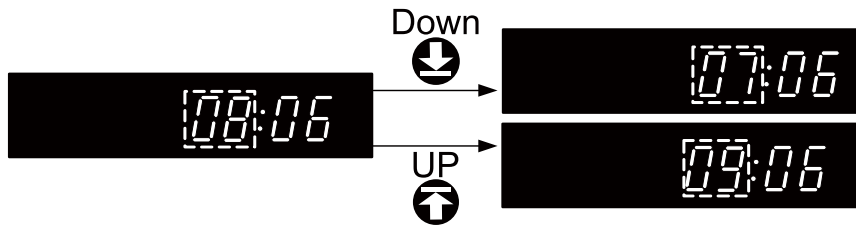

- Set the Minute:

When finished the hours setting then the minute number will flashing, press UP and Down buttons to change the minute number, and press Enter button to confirm and finish the hour setting.

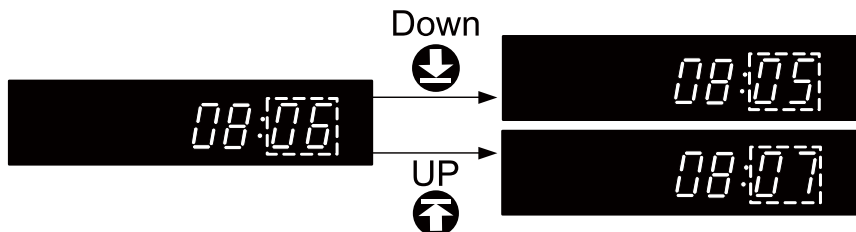

After confirmed and finished the hour setting, the area ① will still flashing, you can press Return button to exist the setting process, or press UP and Down buttons to select other setting options, or press Enter button to set the time again.

#### 4.2.4 Battery Settings

Press Return button, then press UP or Down buttons to select area ③ (when area ③ is flashing), then press Enter button to start the battery settings.

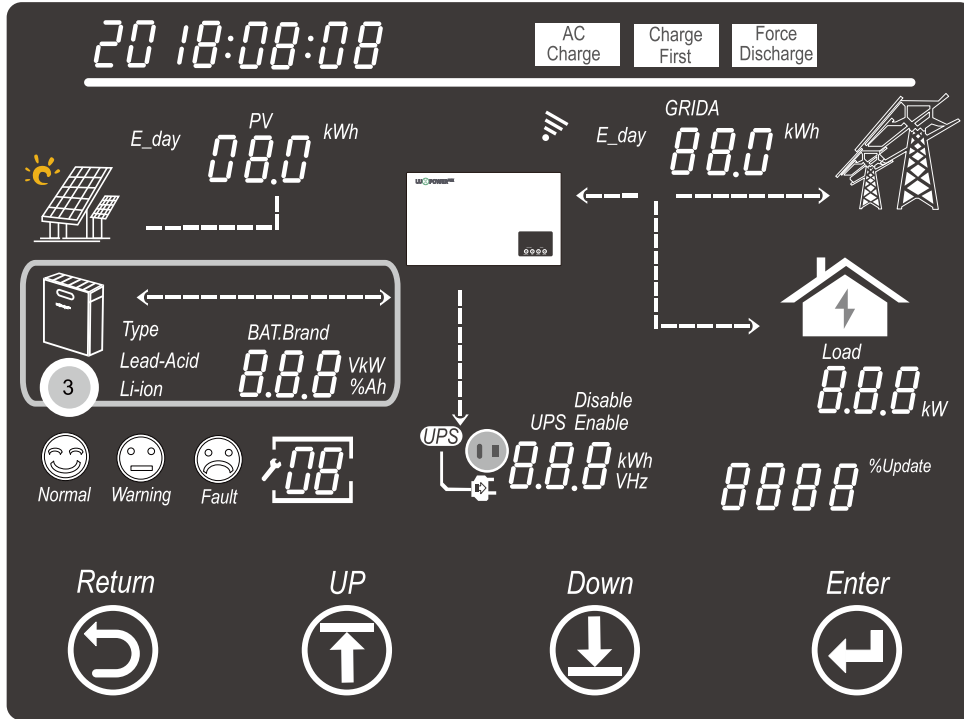

Press Enter button to select battery type (Lead-Acid or Li-ion).

- For Lead-Acid battery:

Select the Lead-Acid option and then press Enter button to confirm the battery type, then the following battery capacity area (50Ah) will flash then please select the lead-acid battery capacity by pressing the UP and Down buttons, the lead-acid battery capacity could be 50Ah, 100Ah, 150Ah, 200Ah and 250Ah. Then press Enter button to confirm and finish the lead-acid battery settings.

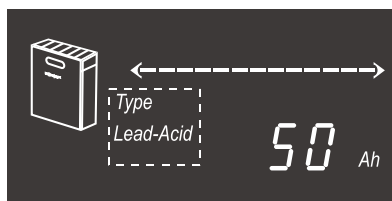

- For Lithium-ion battery:

Select the Li-ion option and press Enter button to confirm the battery type, then the battery brand area will flashing, press UP and Down button to select the battery brand number (see the list battery brand number table), and press Enter button to confirm and finish the lithium-ion battery settings.

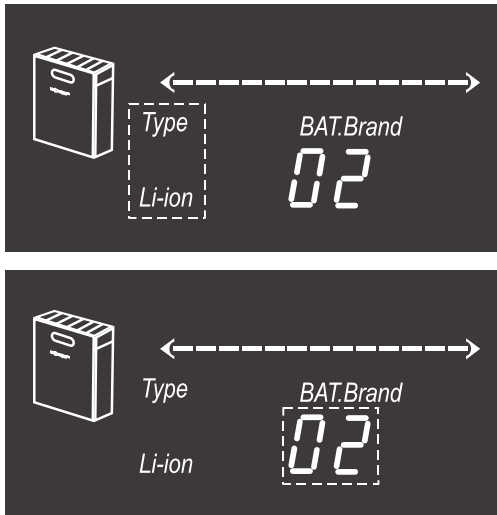

BAT. Brand number	Battery Brand
0	Reserve
1	Reserve
2	Pylon Tech
3	Reserve
4	Reserve
5	Reserve
6	Reserve
...	...

#### 4.2.5 UPS Settings

To use the UPS (sometimes regarded as EPS or back-up function) function, it must be enabled through the UPS settings.

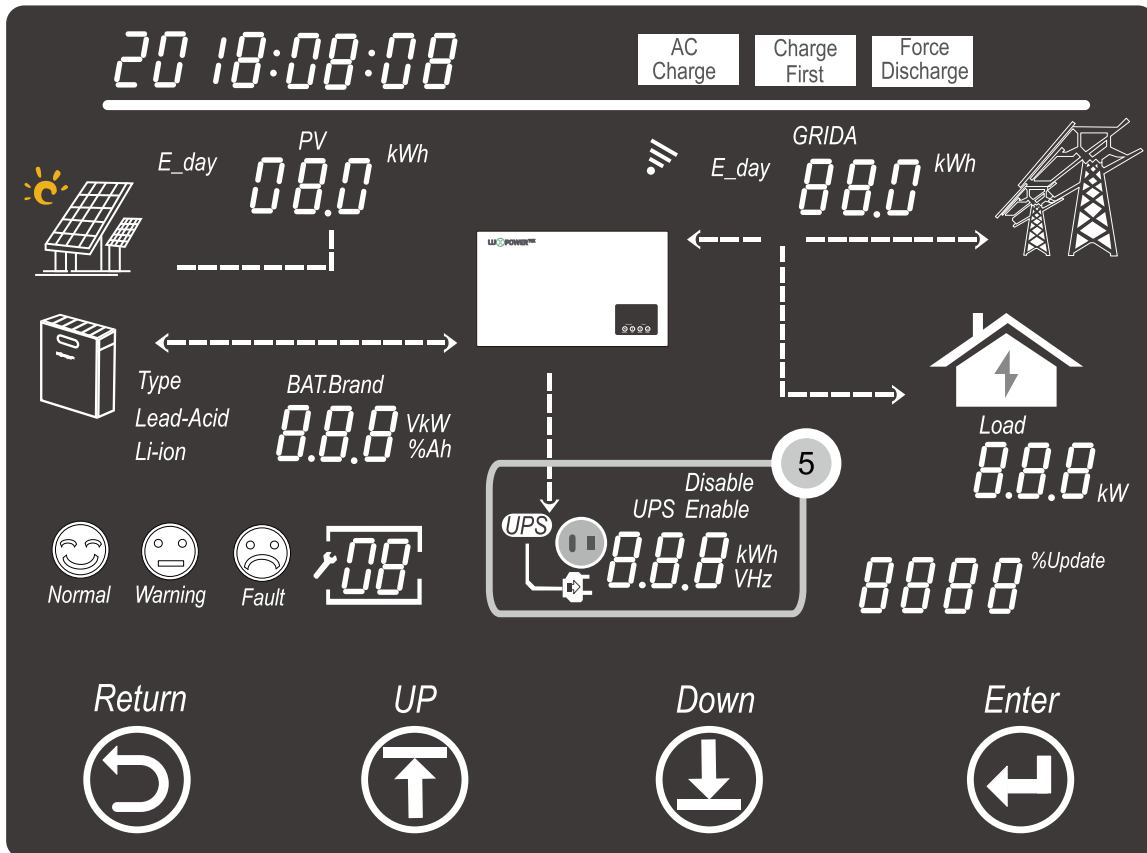

Press Return button to get into setting mode, then press UP and Down button to select the area ⑤ (when area ⑤ is flashing), then press Enter button to start the UPS settings.

- Enable/Disable UPS function:

Press UP and Down buttons to select the Disable or Enable option when they are flashing, and press Enter button to enable or disable the UPS function.

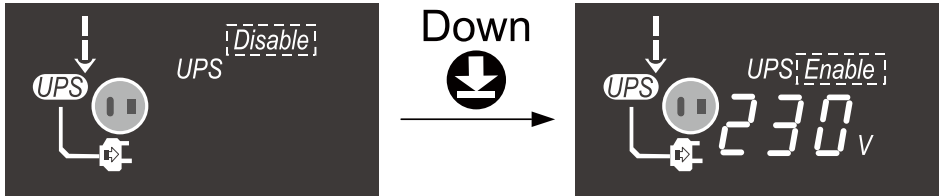

- UPS voltage settings:

When enabled the UPS function, then the UPS voltage area will flash, press UP and Down buttons to select the UPS voltage to be 220V or 230V and then press Enter button to confirm and finish the UPS voltage settings.

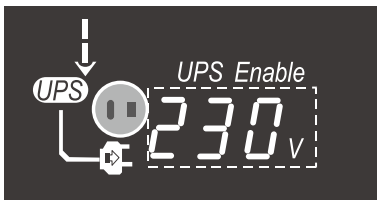

- UPS frequency settings:

When confirmed and finished the UPS voltage settings, then the UPS frequency area will flash, press UP and Down buttons to select the UPS frequency to be 50Hz or 60Hz and press Enter button to confirm and finish the UPS settings.

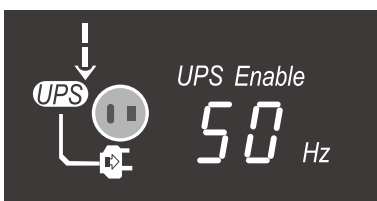

### 4.2.6 AC Charge Settings

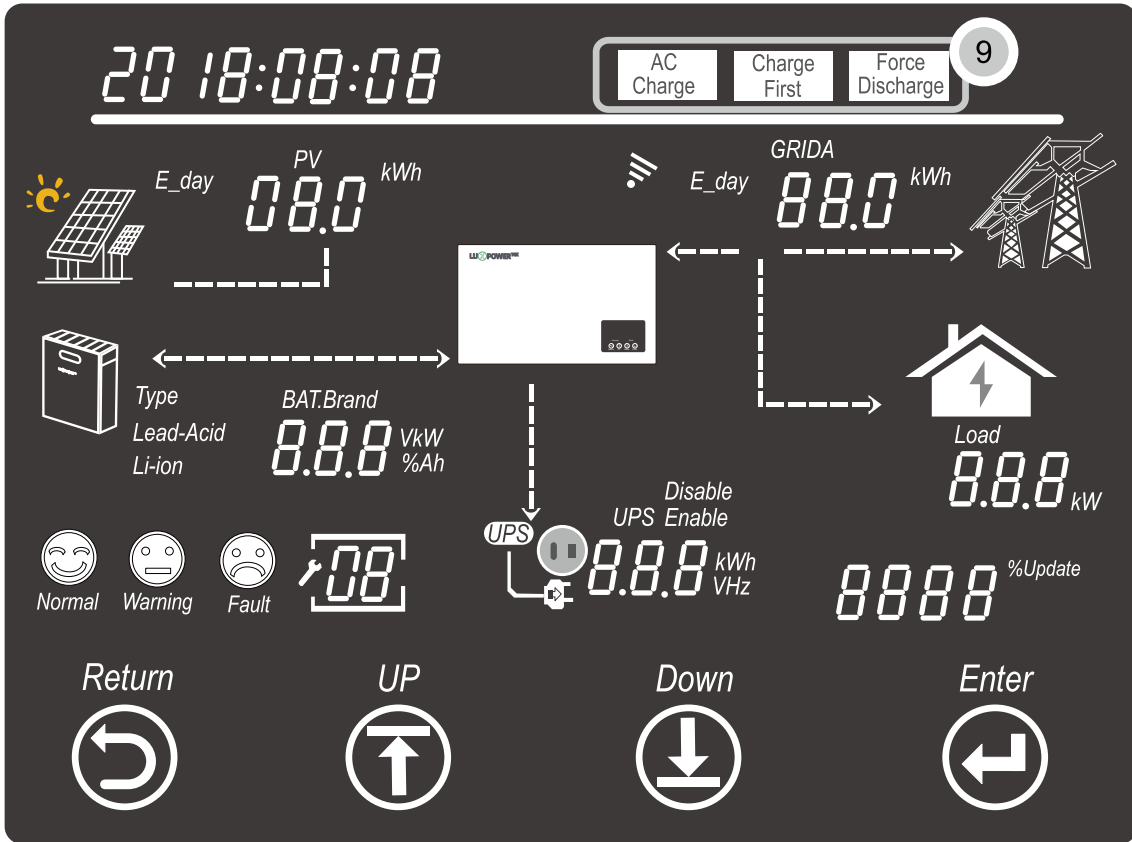

Press Return button to get into setting mode, and press UP and Down button to select the AC Charge option of area ⑨ is flashing, then press Enter button to start the AC charge settings.



- Enable/Disable AC charge function:

Press UP and Down buttons to select the Enable or Disable options of AC charge settings to enable or disable this function, and press Enter button to confirm to enable or disable AC charge function.

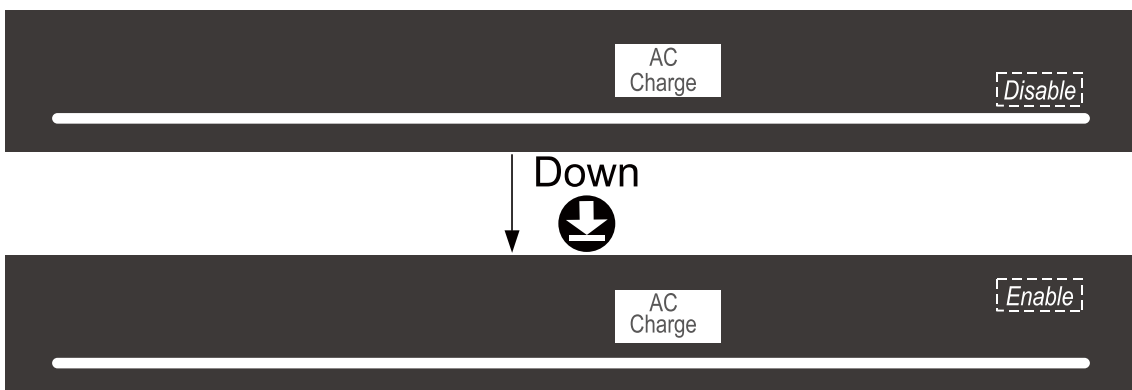

- AC charge power limit rate settings:

When enabled the AC charge function, it will turn to the setting of AC charge power limit rate settings which means to set the AC charge power rate against the maximum AC output/input power. Press UP and Down buttons to select the AC charge power limit rate (from 0%~100%), and then press Enter button to confirm and finish the power limit rate setting.



- AC charge SOC limit rate settings:

When confirmed and finished the AC charge power limit rate settings, it will turn to the battery AC charging SOC limit rate settings which means to set the SOC limitation which once SOC is above this set rate then stop AC charging. Press UP and Down buttons to select the SOC limit rate (from 0% ~100%), and then press Enter button to confirm and finish the SOC limit rate settings.



- AC charge time settings:

When confirmed and finished the AC charge SOC limit rate settings, it will turn to the AC charge time settings. To set the first AC charge time period, press UP and Down buttons to select the AC charge start time 1 and press Enter button to confirm it, then set the AC charge and time 1 and press Enter button to confirm and finish the AC charge time period 1 settings, and it will turn to AC charge time period 2 settings and AC charge time period 3 settings, or you can press Enter button for 8 times to get over the time period 2 and 3 settings if you don't want set them.

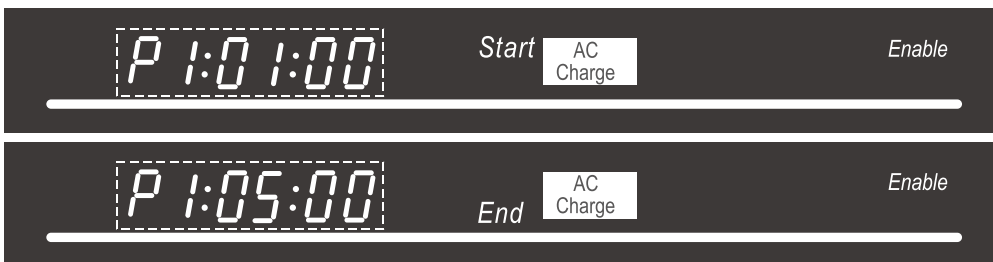

#### 4.2.7 Force Discharge Settings

If the system has to change the working modes to forced discharge the battery stored energy, then we need to enable the Force discharge function and make settings.

Press Return button to get into setting mode, and press UP and Down button to select the Force Discharge option of area ⑨ is flashing, then press Enter button to start the force discharge settings.



The rest of setting of Force Discharge is the same as AC Charge settings.

### 4.3 The Working/Warning/Fault Code Explanation

The system working status will be displayed in area ④, in ways of face icons and status code. Below are the Code explanation for LXP 3600ACS:

Status Code	Inverter Status	Remarks
0	Standby	
1	Fault	
2	Programming	
16	Battery discharge(grid tied)	Battery discharge when on-grid
32	AC charge	Charge battery use grid power
64	Battery discharge(off-grid)	Battery discharge when off-grid

## 5. Start UP And Shutdown

### 5.1 Start-UP The LXP 3600ACS System

Users can start-up LXP 3600ACS through following steps:

**Step 1.** Turn on the grid side AC circuit breaker to connect to Grid.

**Step 2.** Wait 10 seconds.

**Step 3.** Turn on the battery side DC circuit breaker to connect to Battery.

**Step 4.** When the working information is displayed on LCD screen and the icon of the battery is flashing, then set the type of the battery and finish, the inverter will restart after the setting.

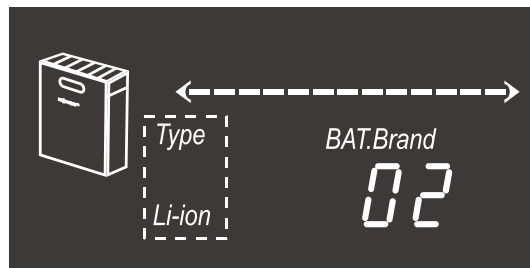

**Step 5.** When the working information is displayed on LCD again and the battery is not flashing, it means that the LXP 3600ACS system is starting up successfully.

### 5.2 Shut-down the LXP 3600ACS System

**Step 1.** Turn off all the circuit breakers and switches, make sure that the grid connection, battery connection, PV connection and UPS connection are all disconnected by turning off the relevant breakers and switches.

































**Step 2.** Wait for 5mins and the LXP 3600ACS is shut down completely.



































## 6. Troubleshooting&Maintenance

### 6.1 Troubleshooting

Once there are any warning or fault occurred, the LED and LCD will displays information to remind the operator, the LCD will display relevant error code and short description.

LCD Display	Description	Troubleshooting
 	Internal communication fault 1	Restart inverter, if the error still exist, please contact us.
 	Model fault 1	Reset model, check if the safety standard switch is in right place.
 	Parallel CNA fault	Check the parallel CAN cables between inverters.
 	Master loss	1. Check the parallel CAN cables between master to slaves. 2. Check if the parallel system is lock of a master inverter, and reconfigure a master.
 	Multiple master	1. Check if the parallel system have two masters at less. 2. Only allow one master, reconfigure the others to slaves.
 	Parallel AC inconsistent	1. Check the AC between parallel inverters.
 	USP short circuit	1. Check UPS L, N connection. 2. Disconnect the UPS connector, if the error still exist, contact us.
 	USP power reversed	Restart the inverter, if the error still exist, contact us.
 	Parallel phase abnormal	Check the AC connection between triphase parallel system.
 	Relay fault 1	Restart inverter, if the error still exist, please contact us.
 	Internal communication fault 2	Restart inverter, if the error still exist, please contact us.
 	Internal communication fault 3	Restart inverter, if the error still exist, please contact us.
 	Bus voltage high	Wait for the inverter automatically restart complete, if this error repeats for several, contact us.
 	UPS connection fault	Check UPS and AC connections.
 	Over current	Restart inverter, if the error still exist, please contacts us.
 	Neutral fault	Check neutral connection.

 Fault		Temperature over range	Check NTC connection.
 Fault		Internal fault	Restart inverter, if the error still exist, please contacts us.
 Fault		Sampling inconsistent between main and slave CPU	Restart inverter, if the error still exist, please contacts us.
 Fault		Internal communication fault4	Restart inverter, if the error still exist, please contacts us.
 Warning		Communication failure with battery	Fix communication cable, if the warning still exist, contacts us.
 Warning		Communication failure with CT	Fix communication cable, if the warning still exist, contacts us.
 Warning		Battery failure	Restart battery, if the warning still exist, please contacts us.
 Warning		Auto Test failure	Restart inverter, if the warning still exist, please contacts us.
 Warning		No AC connection	Check AC connection.
 Warning		AC voltage out of range	Check AC grid voltage.
 Warning		AC frequency out of range	Check AC grid frequency.
 Warning		Leakage current high	Restart inverter, if the error still exist, please contact us.
 Warning		DC injection high	Restart inverter, if the error still exist, please contact us.
 Warning		Battery voltage high	Check and fix battery connection.
 Warning		Battery voltage low	Check and fix battery connection.
 Warning		Battery open circuit	Check and fix battery connection.
 Warning		UPS over load	Check and adjust UPS load.

## 6.2 Maintenance

Every segment of the system need to be check monthly/quarterly/yearly according to the detailed requirements of each segment.

### 6.2.1 Inverter Maintenance

- Check the inverter every 6 months or 1 year to verify if there are damages on cables, accessories, terminals and the inverter itself.
- Check the inverter every 6 months to verify if the operating parameter is normal and there is no abnormal heating or noise from the inverter.
- Check the inverter every 6 months to confirm there is nothing covers the inverter heat sink, if there is, shut-down the inverter and clear the heat sink.

### 6.2.2 Battery Maintenance

As per different types battery, from the original manufacturer’s requirements on maintenance, when you carried out these works on batteries, please make sure to fully shut-down the inverter for safety consideration.

## 7. Manufacturer Warranty

As the manufacturer of this inverter, we provide the manufacturer warranty to our products to our users. For detailed information please refer to the warranty card in the packaging of the inverter or contact our service center via email, web message or phone call.

### Contact Shenzhen Lux Power Technology Co., Ltd

Add: 5th floor, Building 11, Hengchangrong High-Tech Industrial Park, Huangtian Comunity, Hangcheng Street Bao’an District, Shenzhen, China

Tel: +86 755 8520 9056

Mail: info@luxpowertek.com

Web: www.luxpowertek.com

## 8. Specification

Technical Data	LXP 3600ACS
<b>Battery Input Data</b>	
Battery Types	Li-Ion or Lead-acid
Nominal Battery Voltage(V)	48
Max. Charging Voltage(V)	≤60(Configurable)
Max. Charging Current(A)	70
Max. Discharging Current(A)	70
Battery Capacity(kWh)	> 3
Charging Mode for Li-Ion Battery	Self-adaption to BMS
Charging Mode for Lead-acid Battery	3-stage
<b>AC Output Data(On-grid)</b>	
Max. Apparent Power Output to Utility Grid(VA)	3600
Max. Apparent Power from Utility Grid(VA)	6000

Nominal Output Voltage(V)	230
Nominal Output Frequency(Hz)	50/60
Max. AC Current Output to Utility Grid(A)	16
Max. AC Current From Utility Grid(A)	26
Output Power Factor	~1(Adjustable from 0.8 leading to 0.8 lagging)
Output THDI	< 3%
Grid Connection	Single phase
Inrush Current	10A/10us
Max. Output Fault Current	50A/20us
<b>AC Output Data(Back-up)</b>	
Max. Output Apparent Power(VA)	3600
Peak Output Apparent Power(VA)	4700, 30sec
Automatic Switch Time	< 0.01s
Nominal Output Voltage(V)	230(±2%)
Nominal Output Frequency(Hz)	50/60(±0.2%)
Max. Output Current(A)	16
Back-up Over Current Protection(A)	40
Output THDV(linear load)	< 3%
<b>Protection</b>	
Anti-islanding Protection	Integrated(AFD)
Output Over Current Protection	Integrated
Output Short Protection	Integrated
Output Over Voltage Protection	Integrated
<b>General Data</b>	
Operation Temperature Range(°C)	-25~60
Storage Temperature(°C)	-40~65
Relative Humidity	0~95%
Operation Altitude(m)	4000
Cooling	Natural Convection
Noise(dB)	< 25
User Interface	LCD&APP
Interface With BMS	RS 485/CAN
Communication With Cloud	Wi-Fi
Weight(kg)	15.6
Size(Width*Height*Depth mm)	560*320*170
Mounting	Wall Bracket
Protection Degree	IP 65
Environment Category	Outdoor&indoor
Standby Self Consumption(W)	< 10
Topology	High Frequency Isolation
<b>Certifications&amp;Standards</b>	
Safety Regulation&EMC	G83, CE, EN61000-6-1/3, EN62109-6-1/2, AS4777, IEC62040-1







# ■ YOUR RELIABLE ENERGY SOLUTIONS PARTNER



Lux Power Technology Co., Ltd  
Headquarter: +86 755 8520 9056  
www.luxpowertek.com  
Contact us: info@luxpowertek.com



092.20062AA